

SEAN MULLDY

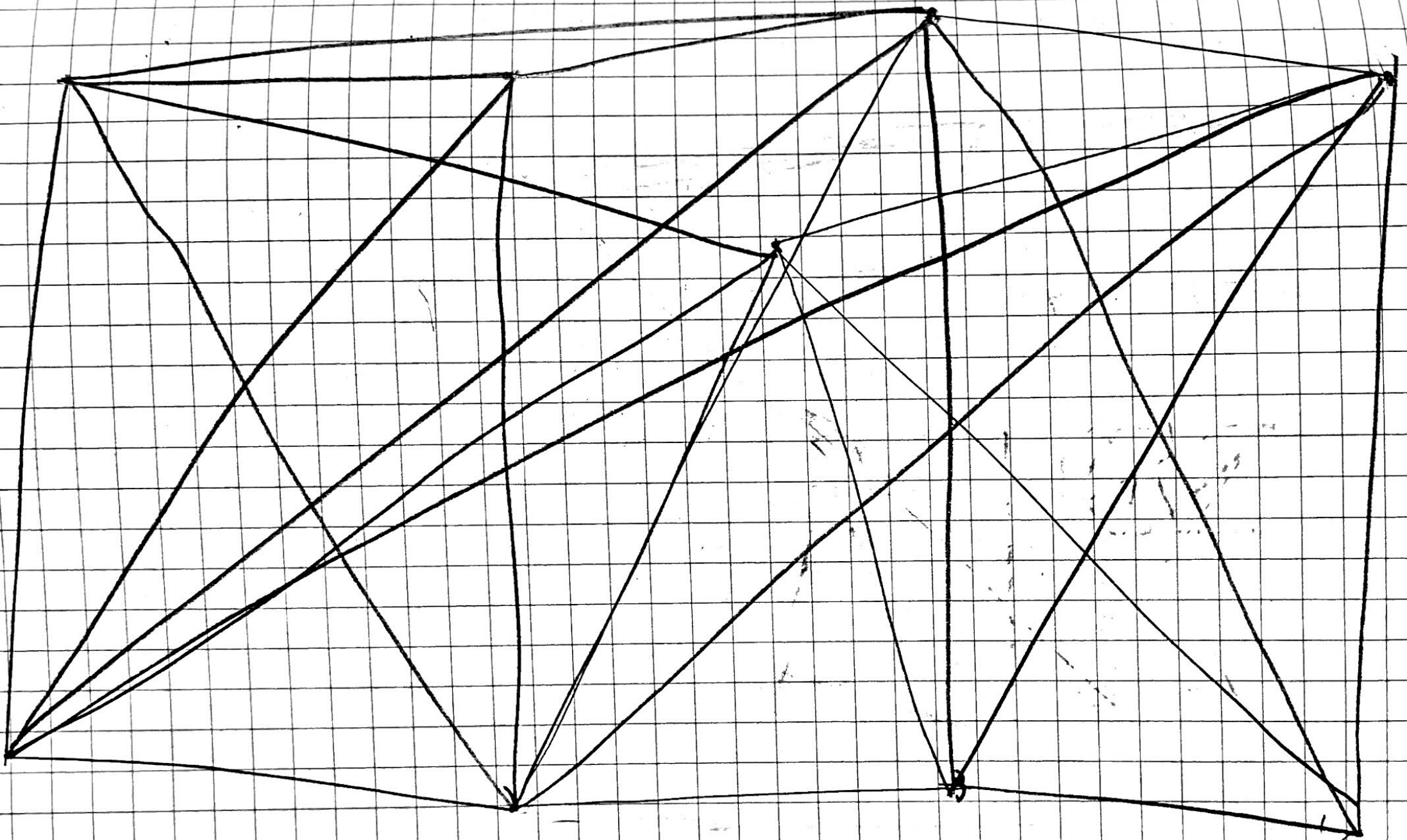

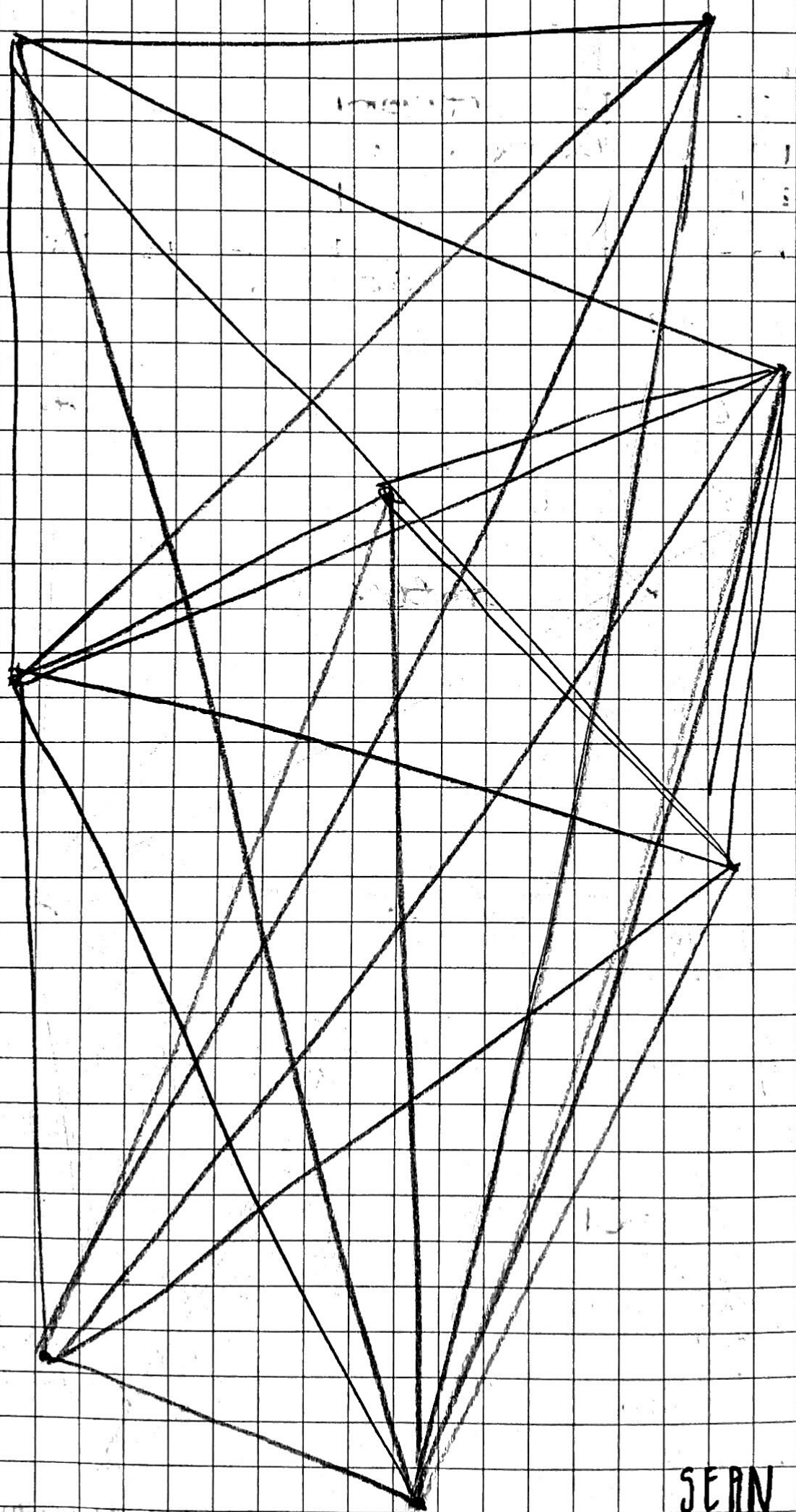

SEAN MULLOY

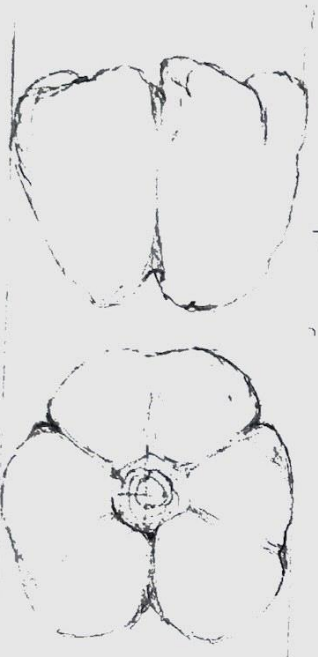

BRICKWORK

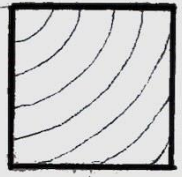

TIMBER - SECTION  
WROUGHT SOFTWOOD

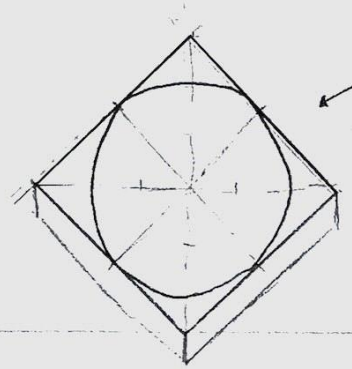
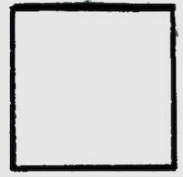

AXONOMETRIC - 45/45 - HEIGHT IS ACCURATE  
ISO - 60/30 - HEIGHT INACCURATE

A B C D E F G H I J K L M N O P Q R S T U V W X Y Z

A B C D E F G H I J K L M N O P Q R S T U V W X Y Z

SEAN MOLLOY SEAN MOLLOY

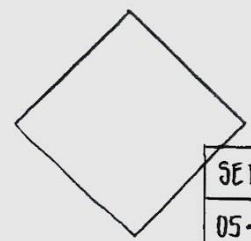

|                |  |
|----------------|--|
| SEAN MOLLOY    |  |
| 05-10-20       |  |
| EXERCISE 2,3,4 |  |



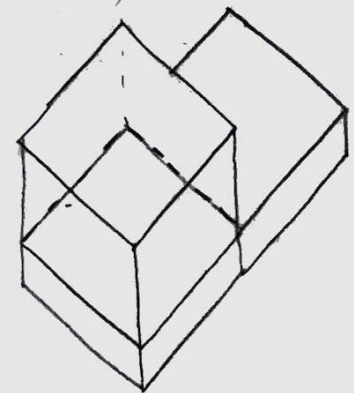
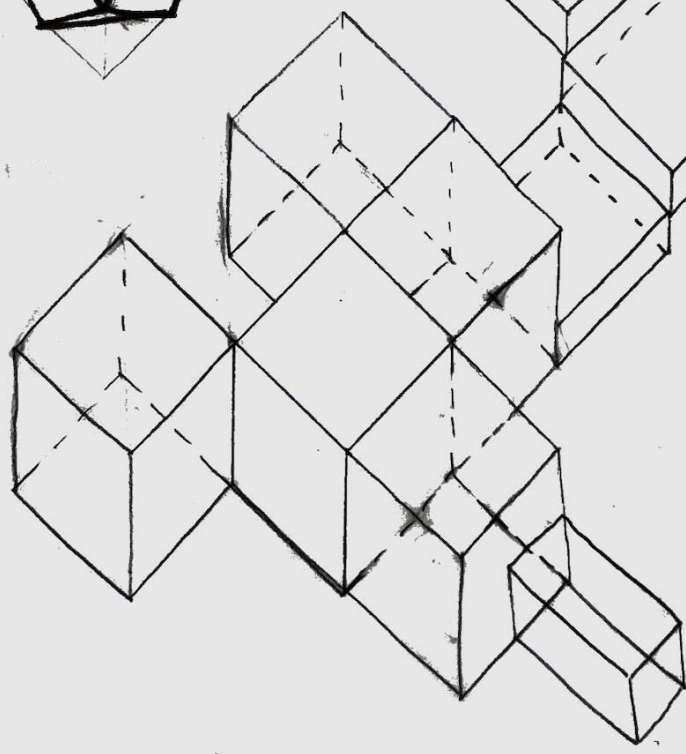
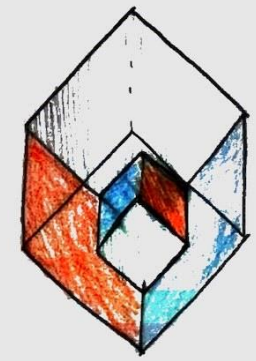
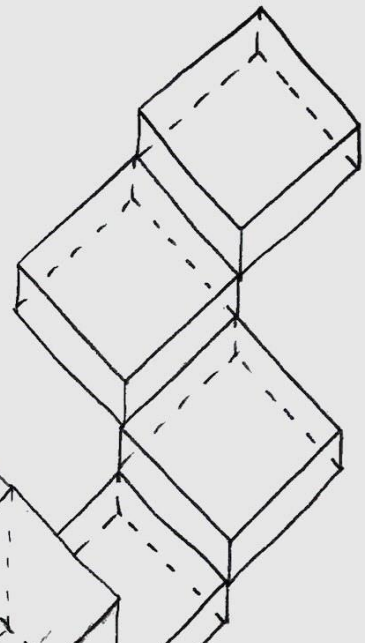
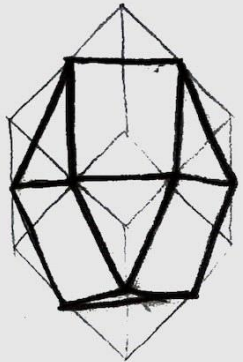
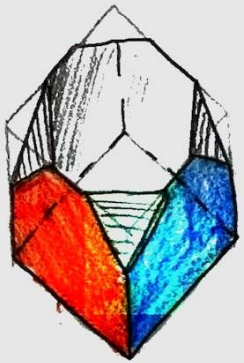

|             |  |
|-------------|--|
| SEAN MOLLOY |  |
| 07-10-20    |  |
| EXERCISE 4  |  |

EXERCISE 5, 6

07-10-20

SEAN MOLLROY

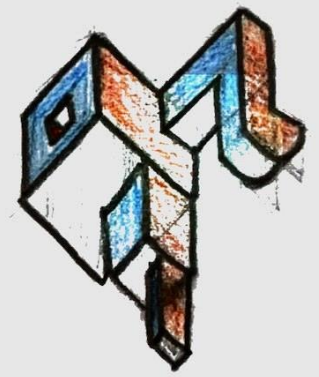
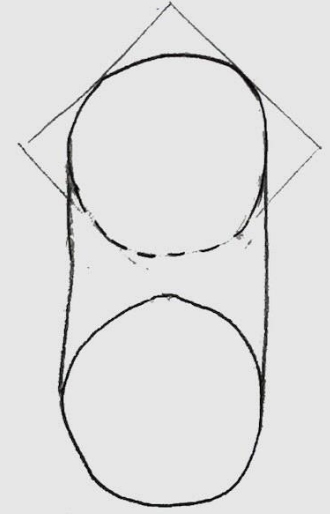
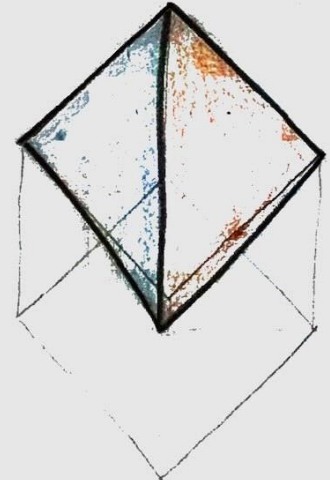
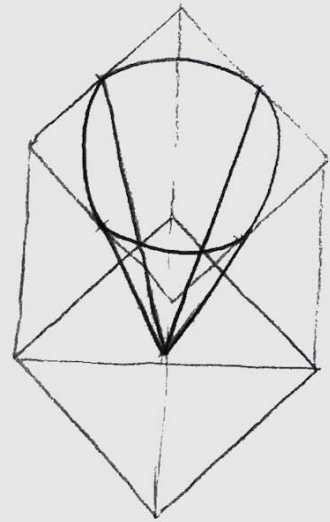



# DESK SOLUTIONS

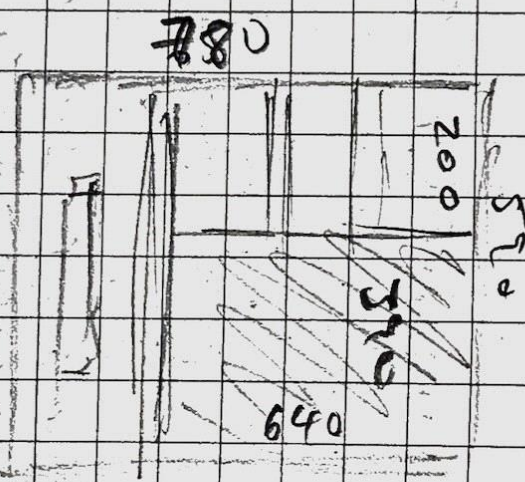
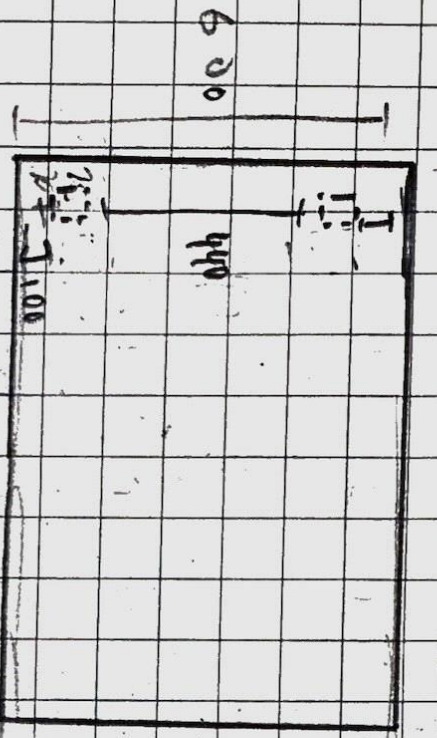
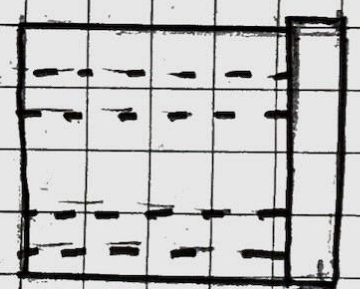
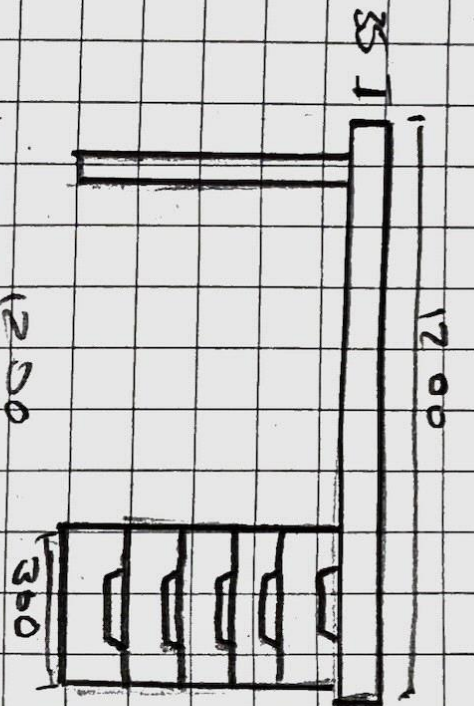

## BATHROOM SOLUTIONS

FLOOR PLAN  
 Elevation of floor when  
 Section v. ends

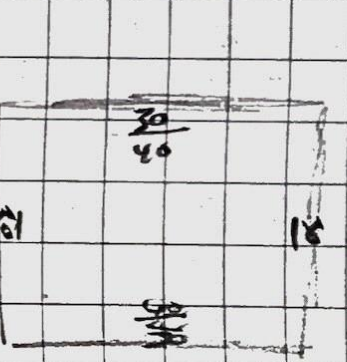
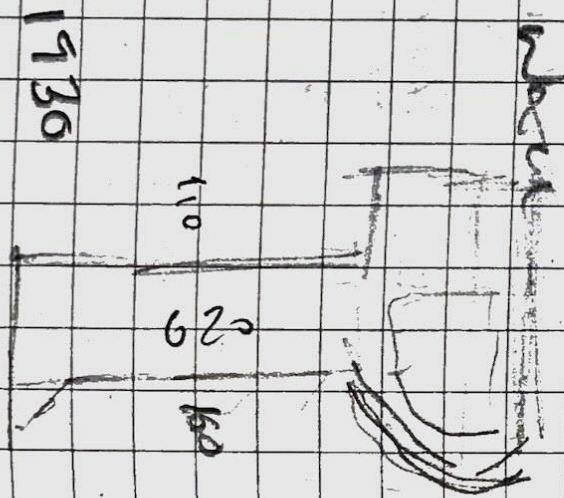
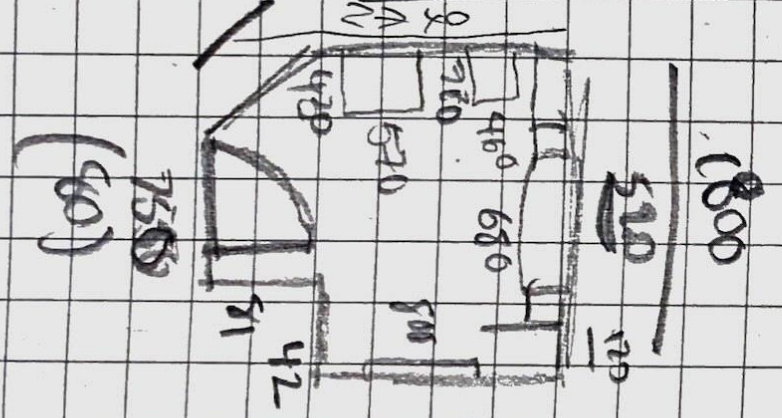
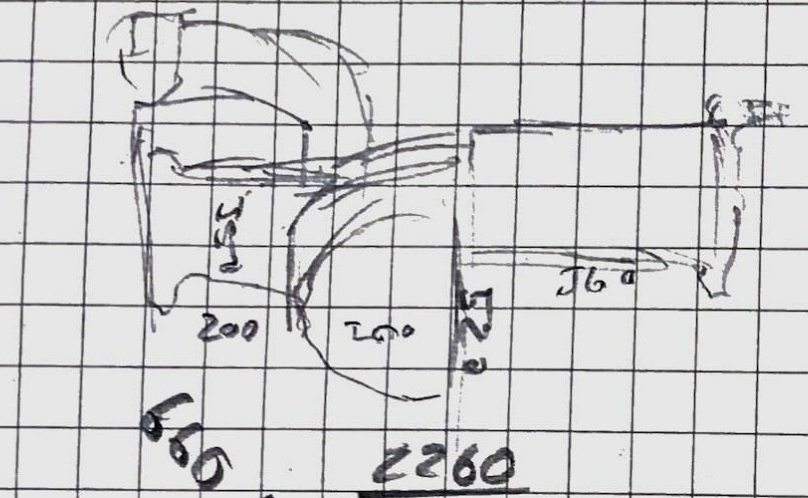

SEAN MOLLOY



Boenc - 440 x 215 x 100  
 BRICK - 215 x 102.5 x 65

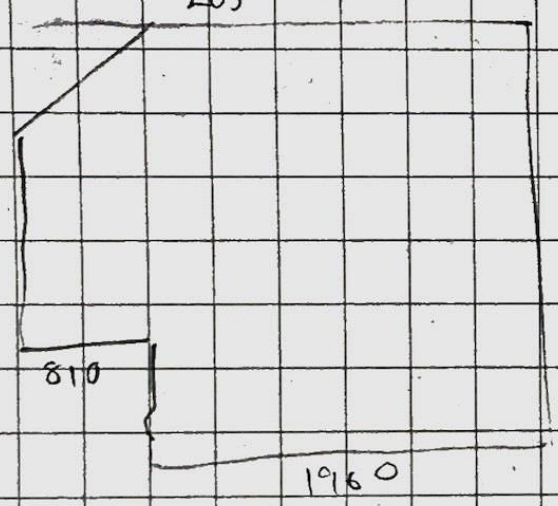
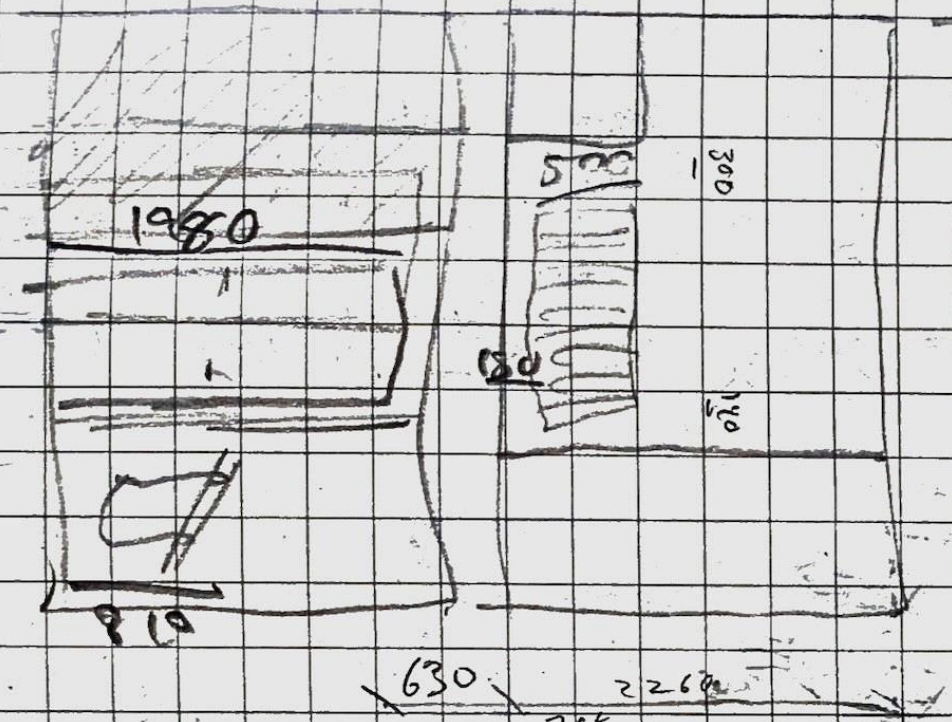
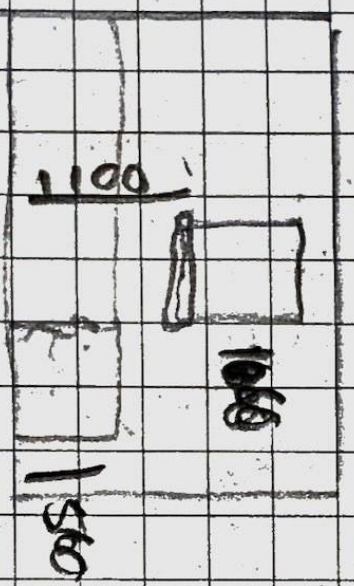
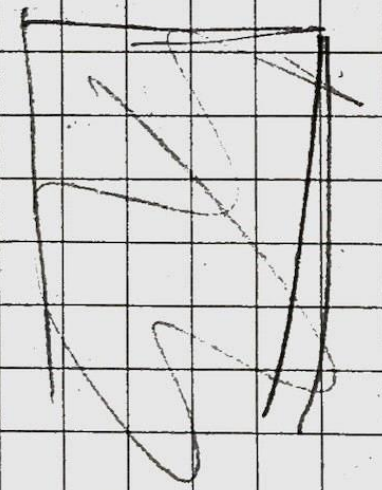
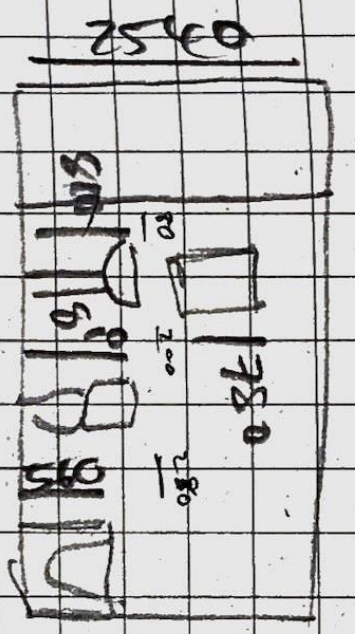

1750

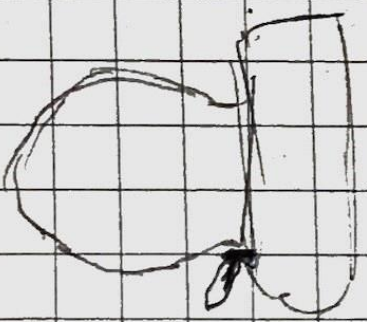

JEAN MOLLY



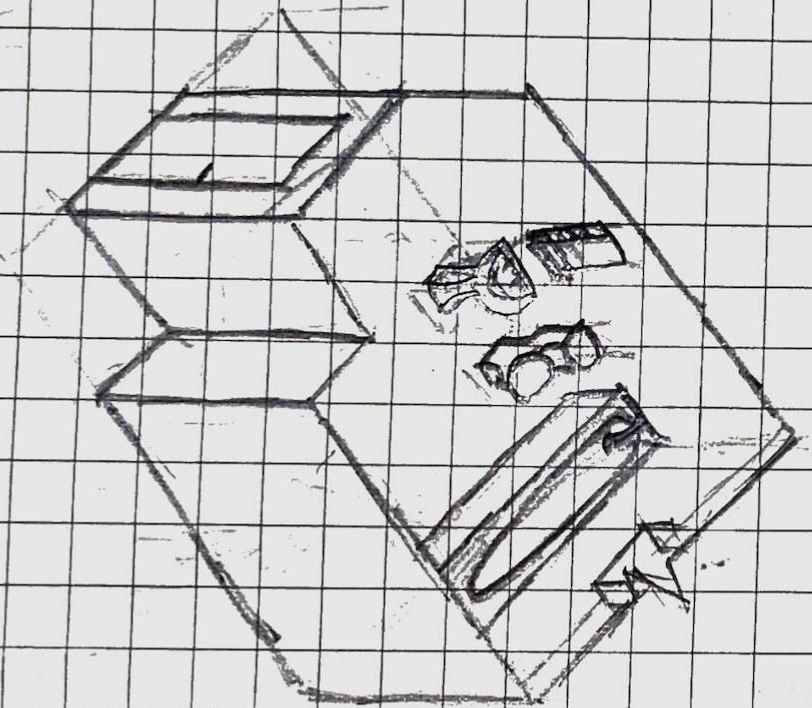
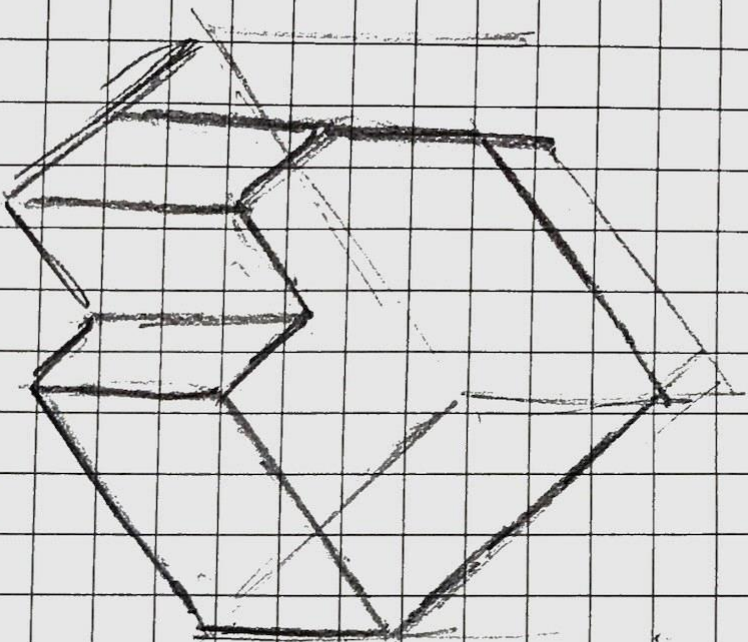

SEAN  
MULLDY

11/19/17



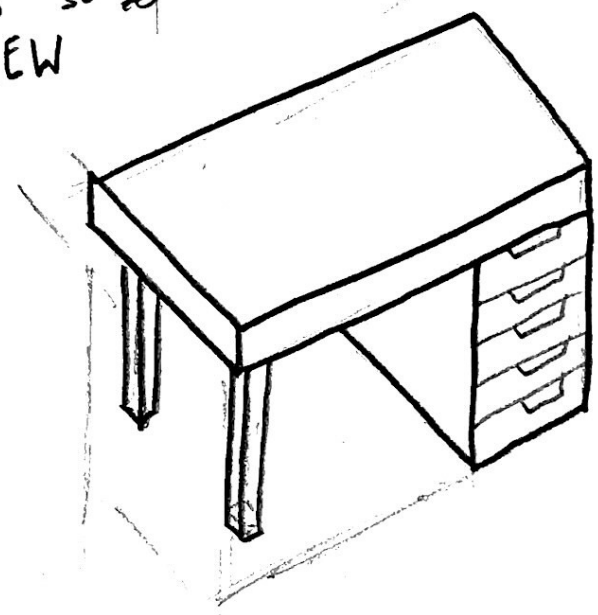
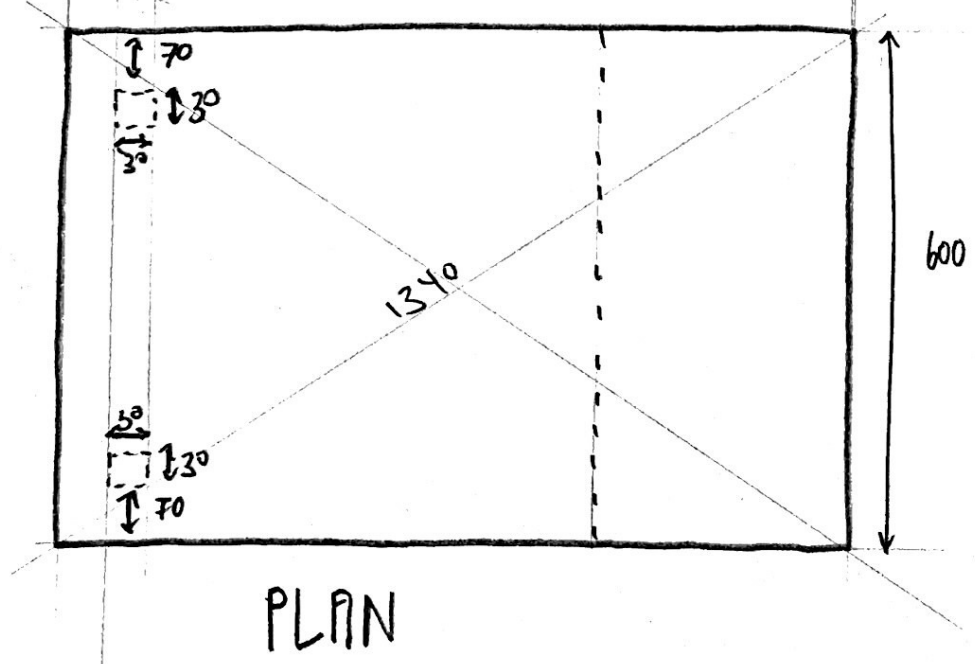
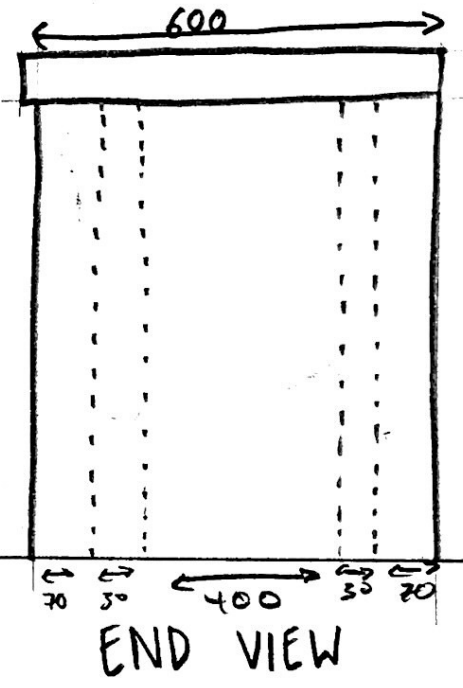
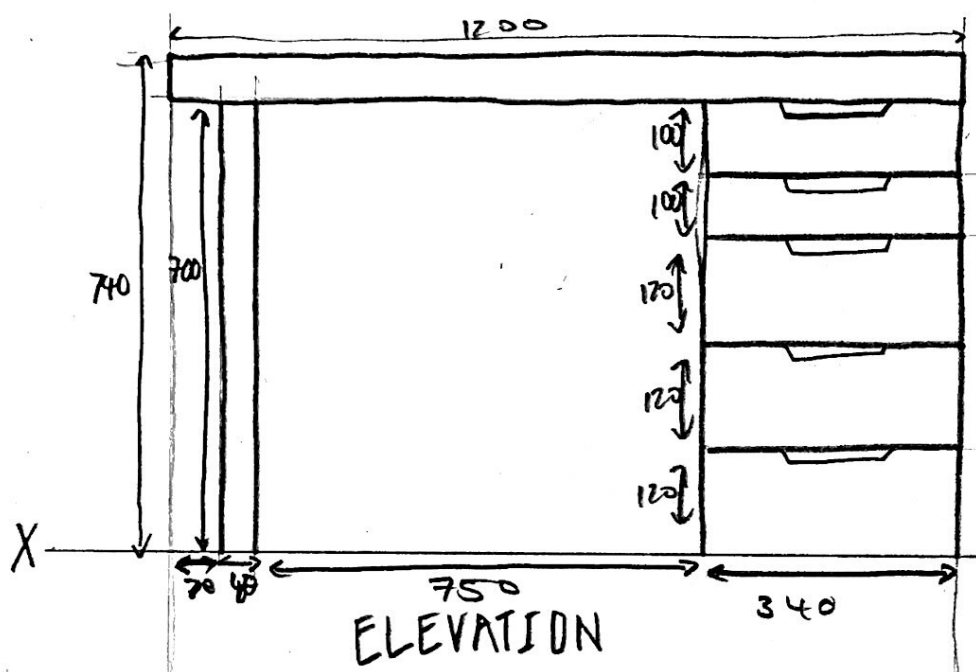

SEAN  
MOLLOY  
07.10.20

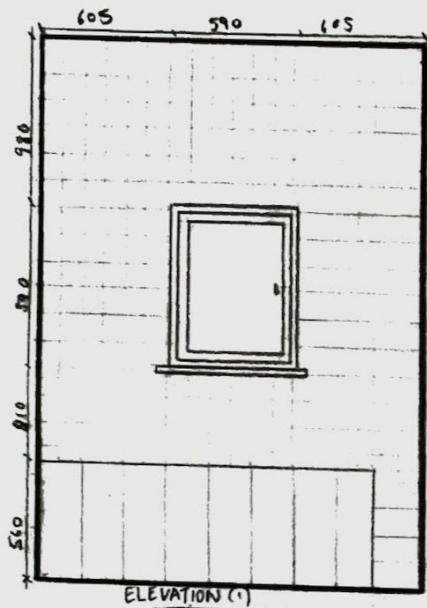

ELEVATION (1)



ELEVATION (2)

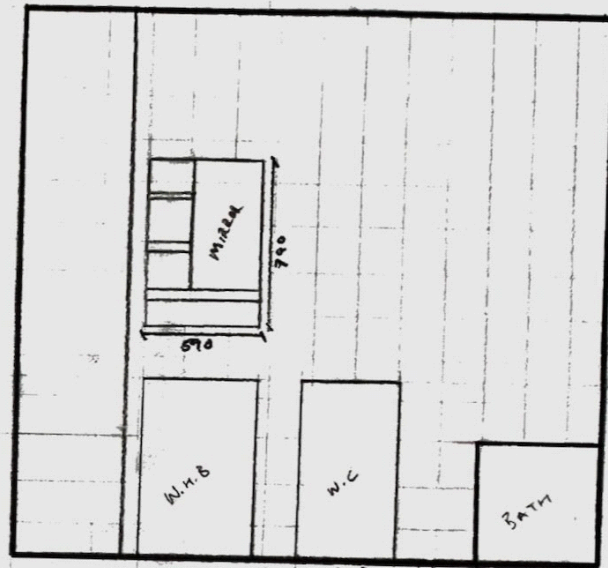

ELEVATIONS (3)

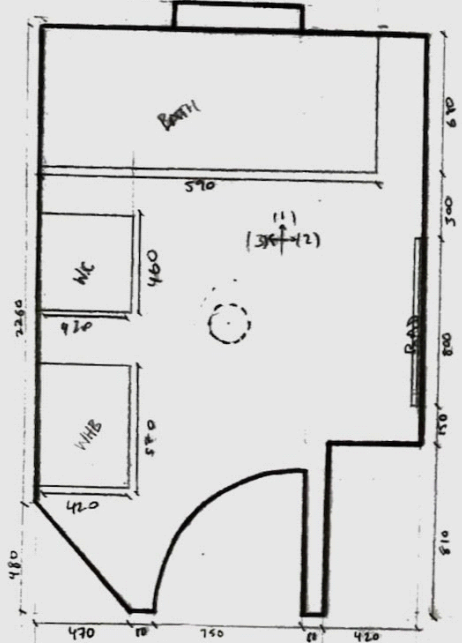

FLOOR PLAN

SEAN MOLLOY  
 C20445642  
 09-10-20  
 1:25



ELEVATION (1)

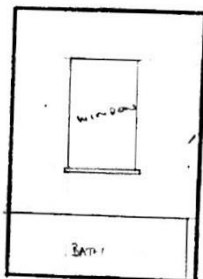

ELEVATION (4)

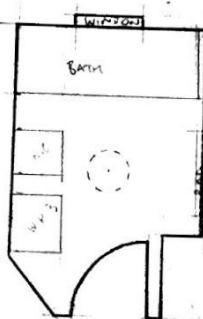
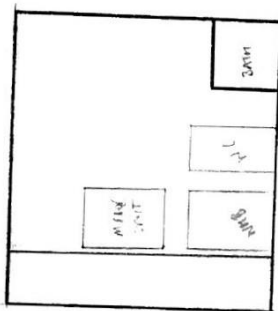

FLOOR PLAN

ELEVATION (2)

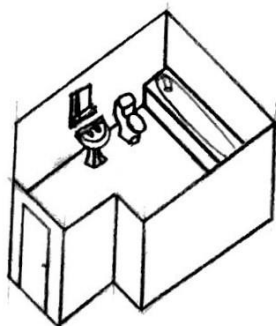
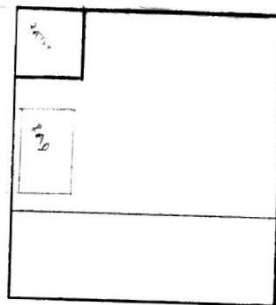

3-D VIEW  
(NOT TO SCALE)

ELEVATION (3)

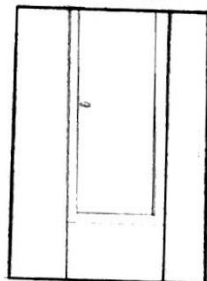

SEAN MOLLOY  
C20445642  
09-10-20  
1:50